

HUNTER

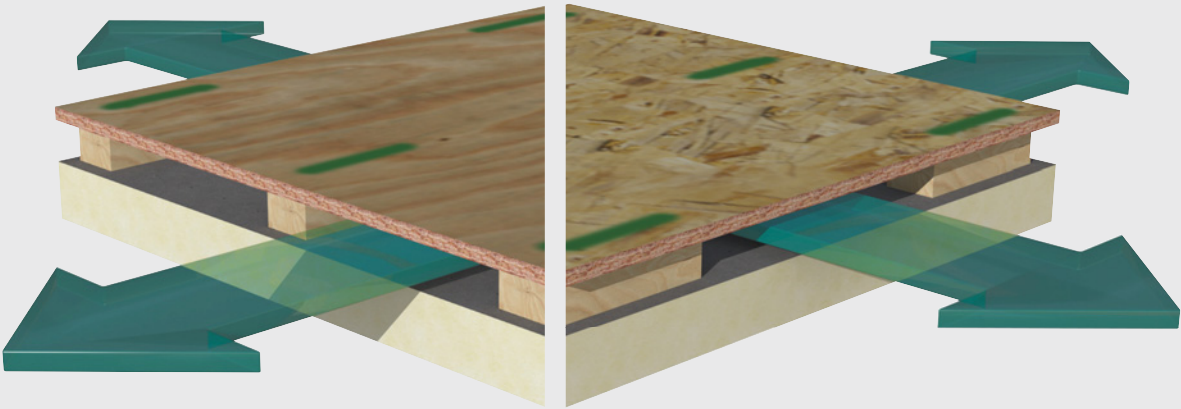

COOL-VENT®

HUNTER



15 Franklin Street ■ Portland, Maine 04101 ■ 888.746.1114 ■ info@hpanels.com ■ www.hunterpanels.com

INSTALLATION AND DESIGN CRITERIA GUIDE

COOL-VENT

Vented Nailbase Polyisocyanurate Insulation Panel for Steep Slope Roof Applications

Cool-Vent is a venting composite insulation board that consists of a 4'x8' panel of closed cell rigid polyisocyanurate, a middle layer of solid wood spacers, creating a standard 1" air space and a top layer of APA/TECO rated OSB or plywood. Cool-Vent is the environmentally intelligent choice for steep slope roofing applications and is viable in green and sustainable building designs.

APPLICATIONS

Cool-Vent is custom built to incorporate the individual specifications of the building designer. Cool-Vent is for use on slopes of 3:12 or greater (for lower slope considerations see H-Shield NB).

- To achieve optimal thermal performance, Hunter Panels recommends installation of a multi-layered system with staggered joints.

Applicable construction types include:

- Non-insulated Cathedral and Vaulted Ceilings
- Exposed ceiling designs beneath steel, plywood, tongue & groove deck types in commercial and residential constructions
- Log Home applications
- Post & Beam constructions

Acceptable Roof Coverings:

- Shingles
- Slate (Natural and Synthetic)
- Tile
- Standing Seam Metal Roof Systems

PANEL CHARACTERISTICS

- Manufactured with NexGen Chemistry: Contains no CFCs, HCFCs, HFCs, is Zero ODP, EPA Compliant and has virtually no GWP
- 75% lateral air movement
- Optimal cooling and ventilation through 92% open air space
- ASTM C1289 Type II, Class 1, Grade 2 (20 psi)
- Available in 4' x 8' (1220mm x 2440mm) panels in overall thicknesses of 2.5" (64mm) to 5.0" (127mm)
- Multiple Substrate Types Available:
 - OSB: 7/16" or 5/8"
 - Plywood: 5/8", 3/4" (CDX or CDX Fire-Treated)
- The edges of the wood panels are rabbeted to provide for expansion and contraction of the wood while allowing the foam edges to be installed tightly to achieve thermal integrity across the entire roof deck
- Wood spacers less than 12" apart; minimizes deflection
- Design flexibility: 1.5" and 2" wood spacers available for increased air flow (when eave ridge distance is over 20 feet)
- Exceeds requirements of ARMA Tech Bulletin 211-RR-24 regarding minimum depth of air space

POTENTIAL LEED CREDITS FOR POLYISO USE

Energy and Atmosphere

- Optimize Energy Performance

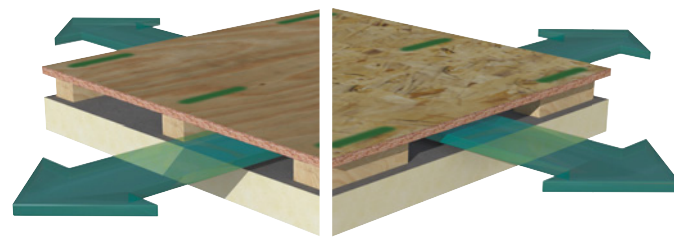

Materials & Resources

- Building Life-Cycle Impact Reduction
- Environment Product Declaration
- Material Reuse
- Recycled Content
- Construction and Demolition Waste Management

Indoor Environmental Quality

- Thermal Comfort

COOL-VENT THERMAL VALUES

Long Term Thermal Resistance Values are based on ASTM C 1289

Thickness [†]		Minimum R-Value	Flute Spanability
(inches)	(mm)		
2.5	64	5.7	2 5/8"
3.0	76	8.6	4 3/8"
3.5	89	11.4	4 3/8"
4.0	102	14.4	4 3/8"
4.1	104	15.0	4 3/8"
4.5	114	17.4	4 3/8"
5.0	127	20.5	4 3/8"

[†]Thickness is calculated with 7/16" OSB and 1" airspace. For other dimensions contact Hunter Panels. Cool-Vent is only manufactured in the sizes listed above and on our packaging and weight chart. R-values other than those listed can be achieved by installing a multi layer system consisting of an additional layer of flat polyiso under Cool-Vent.

DEFINITION OF NFA/LF

The Net Free Area of Ventilation Per Linear Foot is derived by multiplying the air space in inches by the length in inches of the Cool-Vent panel. The area of the wood spaces is then subtracted and the difference is divided by 4 or 8.

Airspace Dimension	NFA/LF
1.0"	7.5/9.5 sq inch
1.5"	11.25/14.25 sq inch
2.0"	15.00/19.0 sq inch

demand. This is a critical consideration for optimum performance and a balanced system and is often overlooked in the design process (see 6: Eave and Ridge Vent Design).

6. EAVE AND RIDGE VENT DESIGN

This very important design feature is critical to consider for every individual roofing project due to the effects of certain variables on the completed system. Slope and length of run play an important role in the role of the vented insulation panel and the achievement of a balanced system. As the length of the run increases, the designer should consider increasing the size of the venting space. However, air intake (fascia design) and air output (ridge vent design) must be increased proportionally. Failure to do so may lead to future problems such as underlayment and shingle buckling.

PLEASE NOTE: When increasing the size and volume intake of the cavity area from 1.0" to 1.5" or 2.0", both the intake area at the fascia and the output area at the ridge should also be increased to handle the extra demand. This is a critical consideration for optimum performance and a balanced system and is often overlooked in the design process.

7. USE OF SYNTHETIC UNDERLAYMENTS

The use of synthetic underlayments is becoming the industry norm for steep slope roofing assemblies. Hunter Panels strongly suggests the use of a synthetic underlayment under asphalt shingles unless the shingle manufacturer has specifically eliminated it. Synthetic underlayments offer several key advantages over traditional asphalt felt:

- Larger rolls with fewer laps and less nailing
- Lighter weight for easier handling and quicker installation
- May be left exposed for longer periods of time without organic deterioration
- Synthetic reinforced polypropylene wicks the moisture and provides excellent water resistance
- Some manufacturers of synthetic underlayment offer products with prolonged exposure to UV rays, greater fire resistance, tear strength and puncture resistance

Hunter Panels does not recommend the use of 15# and 30# roofing felt as an underlayment to asphalt shingles on our Cool-Vent product. Use of these felt products will void any and all claims regarding a Cool-Vent assembly. Hunter Panels cannot be responsible for claims arising out of aesthetic anomalies caused by roofing felts in the assembly.

8. SHINGLE CONSIDERATION

The roof covering is one of the most important considerations of any low slope or steep slope application. In most steep slope roofing projects, however, the visual appeal or aesthetic look plays almost as large a role as the true performance and physical properties of the shingle.

Please go to www.hunterpanels.com for the latest product literature, specifications and other documents relating to this product.

WARNINGS AND LIMITATIONS

This material must be kept dry, stored above ground/roof level on pallets and completely covered (top & sides) with a waterproof tarpaulin. Prolonged exposure to moisture will degrade the wood substrate and have a deleterious effect on its performance. Hunter Panels will not be responsible for the performance of this product if it is installed wet. Only install as much product in a day that can be covered with the completed roof system. This panel consists of insulation, wood spacers, and the top layer of OSB or Ply. All materials are glued together for transportation and handling purposes only. Support the panel from the bottom layer when relocating to the desired location. Improper handling may cause components to separate. Separation of the components will not affect the performance of the products once properly installed. Hunter Panels will not be responsible for specific designs by others, for deficiencies in construction or workmanship, for dangerous conditions on the job site, or for improper storage and handling.

WARRANTY

Hunter Panels will not be responsible for leakage, damage or failure of any kind caused by improper application or design, structural movement, accident or natural hazard, defective membrane or improper maintenance.

Hunter Panels warrants that its polyisocyanurate foam will conform to its published physical properties, federal specifications and ASTM standards. Hunter Panels does not warrant the performance or physical properties of the wood substrate incorporated into the Cool-Vent assembly.

Hunter Panels will not be liable for incidental or consequential damages to the structure, its contents or occupancy.

Hunter Panels makes no warranties or guarantees of any kind expressed or implied, including but not limited to implied warranties of merchantability and fitness for a particular purpose except as stated herein.



DESIGN CRITERIA GUIDE

1. CONSTRUCTION GENERATED MOISTURE
2. VAPOR DIFFUSION RETARDERS
3. MULTI-LAYERED ROOF INSULATION
4. FASTENER REQUIREMENTS
5. SLOPES AND INCREASED AIR CAVITIES
6. EAVE AND RIDGE VENT DESIGN
7. USE OF SYNTHETIC UNDERLAYMENTS
8. SHINGLE CONSIDERATION

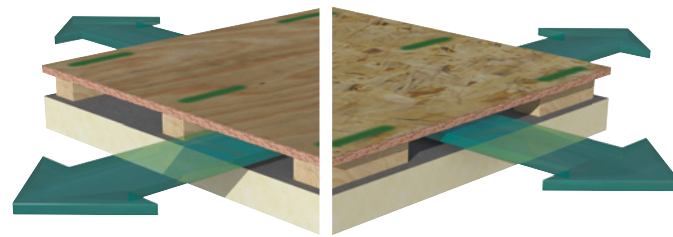

1. CONSTRUCTION GENERATED MOISTURE

Buildings under construction are susceptible to water and or moisture intrusion from the unfinished portions of the roof or adjacent components of the building. Some of the most common sources of moisture drive are:

- Pouring of a concrete floor or other masonry work in an enclosed building
- The use of heaters or "salamanders" to provide more comfortable conditions or help cure the freshly poured concrete
- The use of oil burning heaters
- The use of paint, plaster and other water based construction materials

Effects of moisture generated during construction on the roofing system can cause the following conditions:

- Water accumulation in the steel deck flutes causing corrosion and possible intrusion into the building
- Condensed moisture can promote microorganism growth
- Moisture drawn into the roof system may have a deleterious effect on the physical properties of the roof insulation (i.e. dimensional stability, thermal properties)

Adherence to good construction practices can minimize some or all of the above-mentioned conditions. Adequate ventilation should be provided at all times for enclosed construction to limit moisture drive through the underside of the roof deck. The use of multi-layered roof insulation assemblies will enhance thermal performance as well as restrict the transport of moisture into the roof system. During roof construction, the completed roof section should be tied off each day to protect the new roof from water entry.

2. VAPOR DIFFUSION RETARDERS

In building construction, vapor retarders are used to inhibit or block the passage of moisture into roofing assemblies. Vapor barriers also serve as air barriers to limit the movement of moisture-laden air from the interior to the exterior. This is especially important during the construction phase where excessive moisture drive is present. To determine whether a vapor retarder is necessary, we recommend that calculations on the building's interior relative humidity, interior temperature conditions and outside temperature fluctuations during the various seasons be performed prior to the completion of the design. Excessive moisture migration can cause unwanted condensation that will potentially damage the system or infiltrate the occupied space.

Hunter Panels strongly suggests the use of a vapor retarder with a perm value of 0.5 or less on all projects except in extreme cooling conditions. Consult a licensed design professional, architect or engineer to establish whether or not a vapor retarder is necessary and to specify its type and location within the assembly. This criteria varies with geographical location and is therefore specific to each project.

3. MULTI-LAYERED ROOF INSULATION

Multi-layering of polyiso in any roof application installed with staggered joints offers a number of advantages and is considered good roofing practice because doing so:

- Minimizes thermal loss at the joints of the insulation, prevents thermal bridging
- Prevents moisture from inside of the structure from condensing on the underside of the finished roof system

4. FASTENER REQUIREMENTS

To ensure optimal performance, Hunter Panels **requires** the use of the Hunter SIP SD or Hunter SIP HD for steel deck applications and the Hunter SIP WD for plywood deck applications. Always fasten the Cool-Vent through the designated and marked wood spacers as described in the this literature.

5. SLOPES AND INCREASED AIR CAVITIES

It has been Hunter Panels experience that as the slope of the roof decreases and/or the length of the run from eave to ridge increases, the rate of air movement within the vented cavity is affected. This rate of airflow must be considered in the design of the roofing assembly. Hunter Panels strongly suggests that the venting space is increased for improved air movement when the length of the run is over 20 feet. Hunter Panels' Cool-Vent product can be specified with 1", 1.5" and 2" venting spaces to accommodate many design parameters.

PLEASE NOTE: When increasing the size and volume intake of the cavity area from 1.0" to 1.5" or 2.0", both the intake area at the fascia and the output area at the ridge should also be increased to handle the extra

CODES AND COMPLIANCES

- ASTM C 1289 Type II, Class 1 Grade 2 (20 psi)
- International Building Code (IBC) Chapter 26
- State of Florida Product Approval Number FL 5968
- Miami Dade County Product Control Approved

UNDERWRITERS LABORATORIES INC CLASSIFICATIONS

- TGDY. R20624 Shingle Deck Accessory; Cool-Vent roof insulation is classified for use with any Class A, B, or C asphalt organic shingles, metal or tile roof coverings.
- UL 1256
- Insulated Steel Deck Construction Assemblies - No. 120, 123
- UL 790
- UL 263 Hourly Rated P Series Roof Assemblies

UL CLASSIFIED FOR USE IN CANADA

- Refer to UL Directory of Products Certified for Canada for more details

FACTORY MUTUAL APPROVALS

- FM 4450, FM 4470

TYPICAL PHYSICAL PROPERTY DATA

Polyiso Foam Core Only

Physical Property	Test Method	Value
Compressive Strength	ASTM D 1621	20 psi (138kPa, Grade 2)
Dimensional Stability	ASTM D 2126	2% linear change (7 days)
Moisture Vapor Transmission	ASTM E 96	< 1 perm (57.5ng/(Pa•s•m ²))
Water Absorption	ASTM C 209	<1% volume
Flame Spread*	ASTM E 84	< 75
Smoke Developed*	ASTM E 84	< 450
Service Temperature	-	-100° to 250°F (-73°C to 122°C)

*Meets the requirements of the IBC code. For specific Flame Spread or Smoke Developed Ratings please contact the Hunter Panels Technical Department

FASTENING GUIDELINES

Hunter Panels requires the use of the Hunter Panels SIP SD Panel Fastener for steel deck applications, the SIP WD for plywood deck applications, and SIP HD for heavy duty steel decks.

WARNINGS AND LIMITATIONS

Insulation must be protected from open flame and kept dry at all times. Store above ground on pallets and cover with breathable tarpaulins. Install only as much Polyiso as can be covered the same day with the completed roofing system. Do not leave exposed. This panel consists of insulation, wood spacers, and the top layer of OSB or Ply. All materials are glued together for transportation and handling purposes only. Support the panel from the bottom layer when relocating to the desired location. Improper handling may cause components to separate. Separation of the components will not affect the performance of the products once properly installed. Hunter Panels will not be responsible for specific designs by others, for deficiencies in construction or workmanship, for dangerous conditions on the job site, or for improper storage and handling.

INSTALLATION

- Install Cool-Vent only over fully supported structural decking
 - Cool-Vent is NOT a structural panel
 - Hunter Panels recommends Cool-Vent be applied perpendicular to the flutes in steel deck applications
 - The use of 15# and 30# roofing felt is not recommended under asphalt shingles when using Hunter Panels Cool-Vent product
 - Install Cool-Vent on slopes 3:12 or greater
- NOTE: When installing Cool-Vent over an acoustical deck, check local codes for fire ratings. The use of a 5/8" minimum gypsum fire barrier may be required.

The Use of Synthetic Underlaysments

Hunter Panels strongly suggests the use of a synthetic underlayment under asphalt shingles unless otherwise specified by the shingle manufacturer. Synthetic underlaysments provide excellent water resistance and absorb no moisture.

Vapor Retarders

Vapor barriers also serve as air barriers to limit the movement of moisture-laden air from the interior to the exterior. This is especially important during the construction phase where excessive moisture drive is present. To determine whether a vapor retarder is necessary, we recommend that calculations on the building's interior relative humidity, interior temperature conditions and outside temperature fluctuations during the various seasons be performed prior to the completion of the design. Excessive moisture migration can cause unwanted condensation that will potentially damage the system or infiltrate the occupied space. Hunter Panels strongly suggests the use of a vapor retarder with a perm value of 0.5 or less on all projects except in extreme cooling conditions. This criteria varies with geological location therefore consult a licensed design professional, architect, or engineer to establish whether or not a vapor retarder is necessary and to specify its type and location within the assembly. This criteria varies with geographical location and is therefore specific to each project.

Review manufacturer's specifications and details for complete installation information.



PLAN VIEW / BLOCK ILLUSTRATION

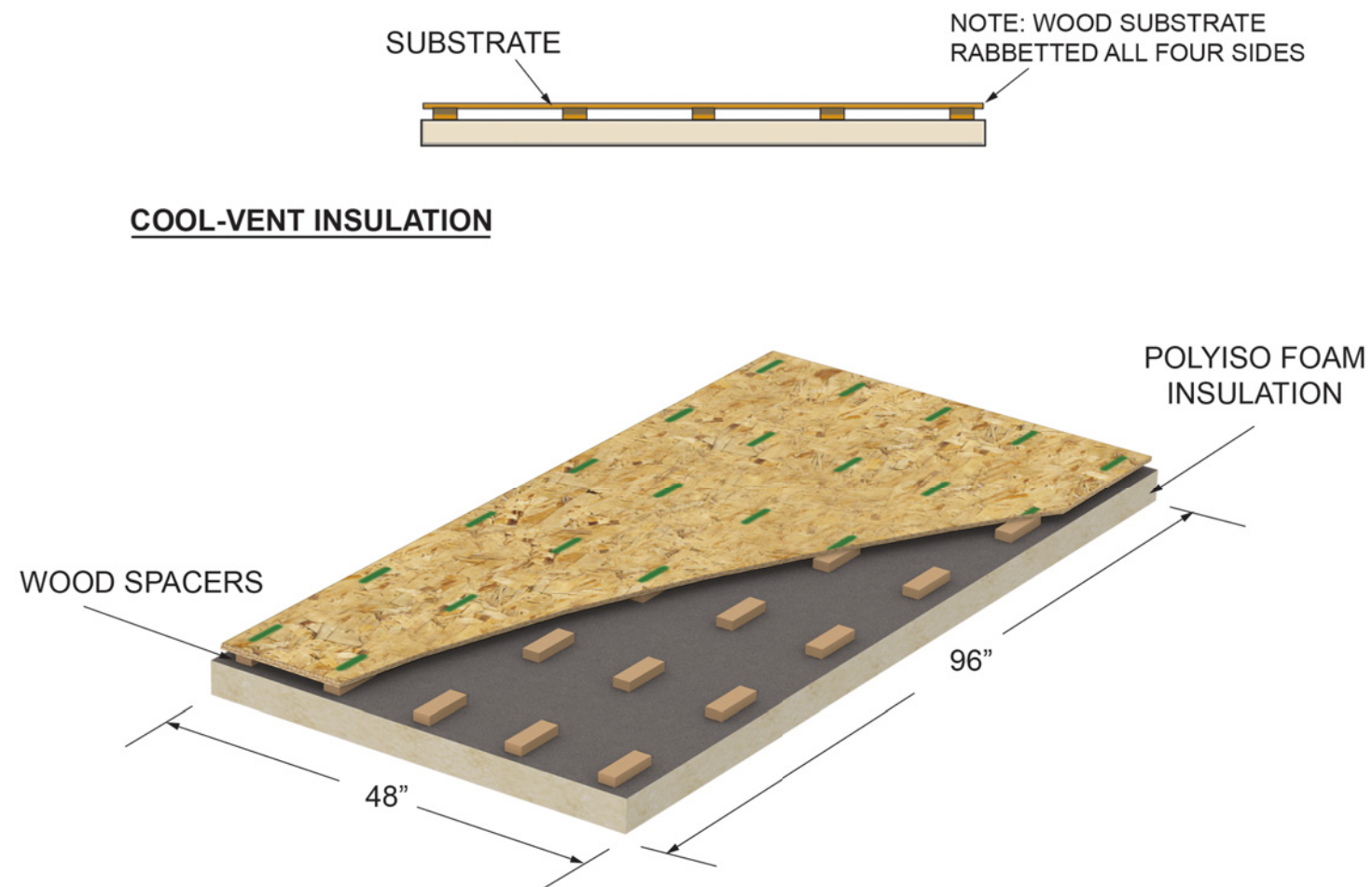

VENTED FASCIA DETAIL

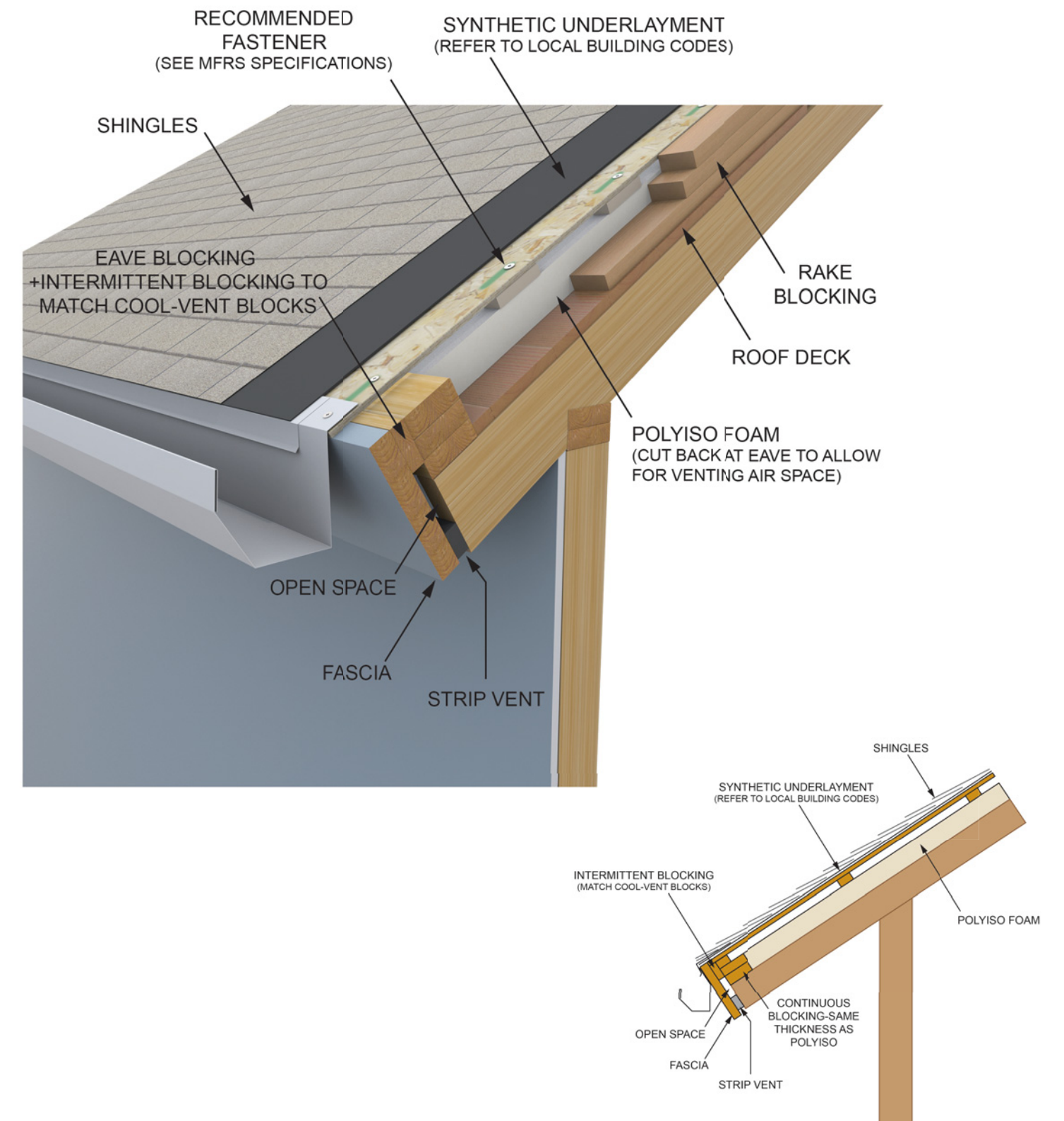

ROOF / WALL DETAIL

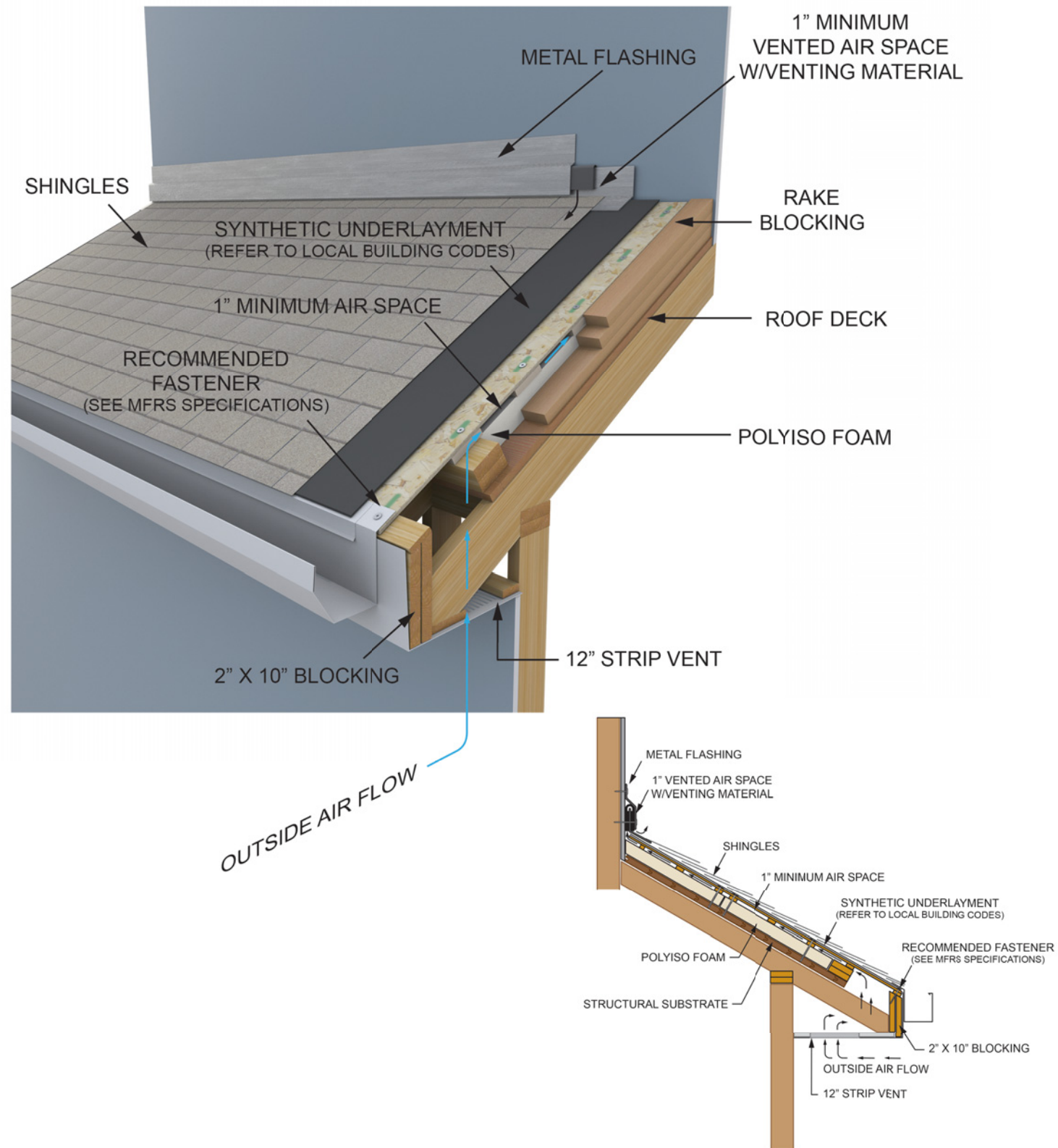

BLOCK MARKINGS

NOTES

- Cool-Vent panels have painted markings on the substrate to indicate block locations. Fasteners need to be installed within 1" of this marked area. On steel decks be sure to fasten into the top flute.
- See pages 7 and 8 for Cool-Vent orientation in regards to flute direction.

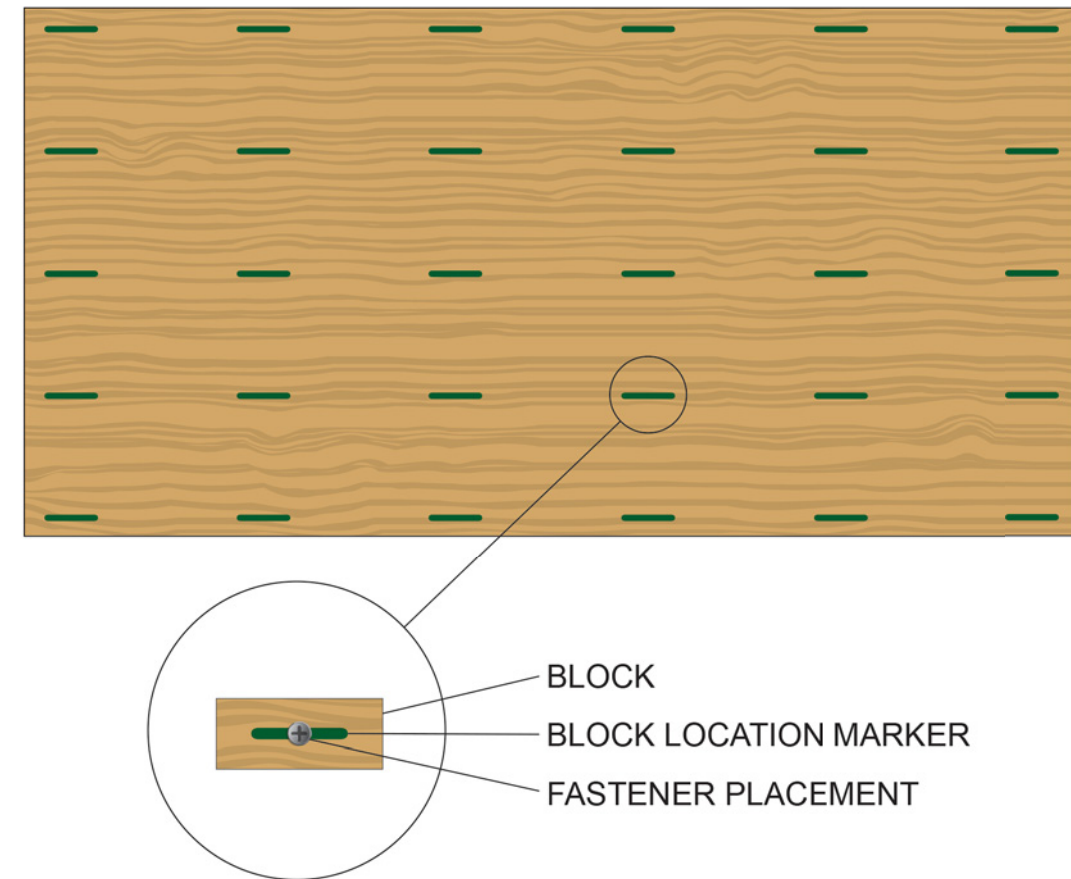

STEEP SLOPE FASTENING PATTERNS FOR COOL-VENT

For slope 3:12 to 12:12

ROOF TYPES

- Shingles
- Slate
- Tile
- Standing Seam Metal

DECK TYPES

- Wood
- Steel



Technical Evaluation Report™

TER 2101-01

TRUFAST® SIP Fasteners for Use in Vented and Non-Vented Nailable Insulation Panels in Roofing Applications

Altenloh, Brinck & Co. US, Inc.

Products:
SIPTP and SIPLD

Issue Date:
May 6, 2021

Revision Date:
February 16, 2023

Subject to Renewal:
April 1, 2024



Use the QR code to access the most recent version or a sealed copy of this Technical Evaluation Report (TER) at drjcertification.org

DrJ Engineering, LLC | 6300 Enterprise Lane | Madison, WI 53719 | drjcertification.org

NOTES

- Cool-Vent must be fastened into a structural roof deck. Cool-Vent is not a structural panel and should not be installed directly to framing.
- Cool-Vent panels have painted markings on the substrate to indicate block locations. Fasteners need to be installed within 1" of this marked area. On steel decks be sure to fasten into the top flute.
- See pages 12 and 13 for Cool-Vent orientation in regards to steel deck flute direction.
- For a complete fastening guide, please contact Hunter Panels or refer to DrJ TER 2101-01.
- For fastening pattern images, please contact Hunter Panels or refer to the Cool-Vent Steep Slope Fastening Pattern Guide on our website.

EAVE DETAIL FOR WOOD DECK (TYP)

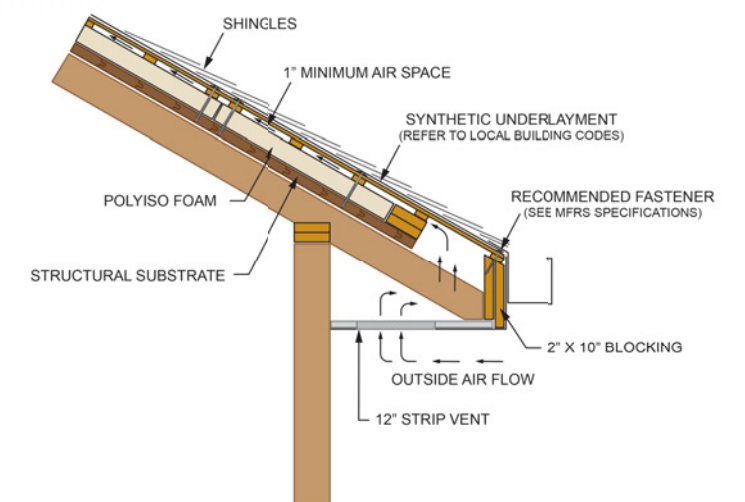
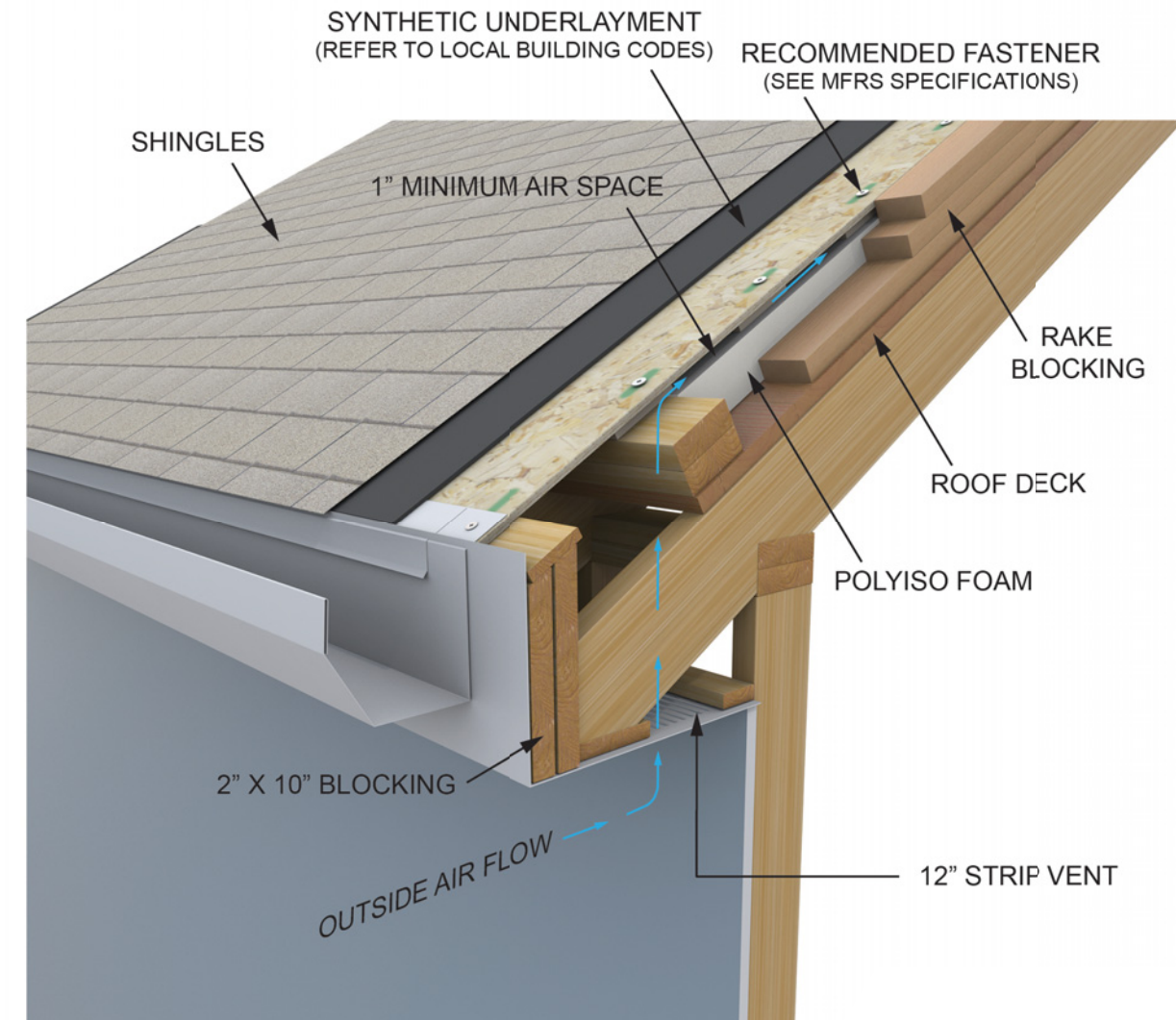

RIDGE DETAIL FOR WOOD DECK (TYP)

NOTES

- It is important that foam butts tightly at top of ridge. Wood substrate should then be cut back to accommodate airflow and ridge cap/vent that is being installed.

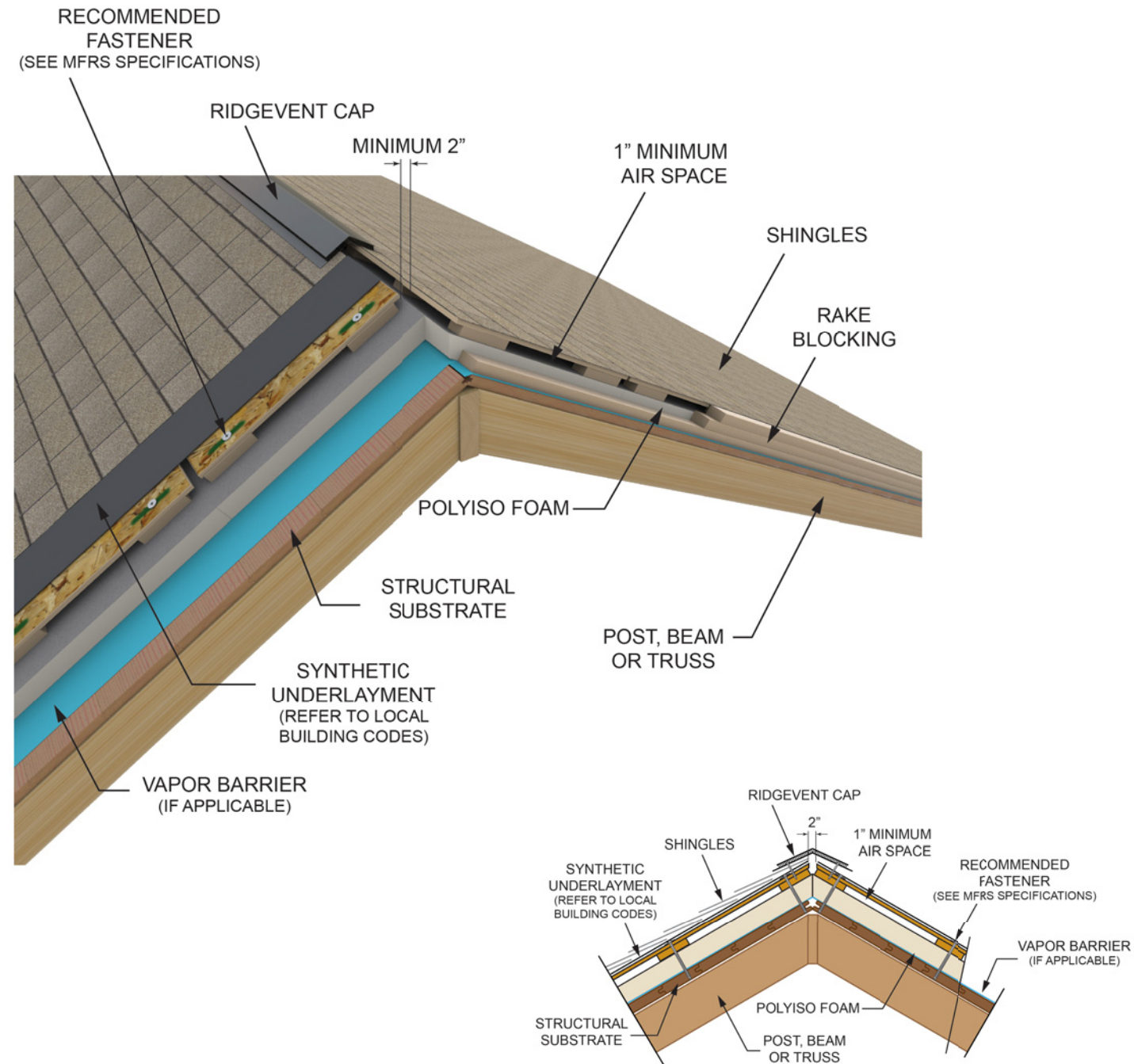

COOL-VENT

Wood, Steel, or Structural Concrete Roof Decks

NOTES

- Please refer to DrJ TER 2101-01 for required number of fasteners per 4' x 8' nailable insulation panel. Where fastening pattern quantities differ from quantities in DrJ TER 2101-01, use pattern with the next highest fastener quantity.

- Cool-Vent panels have painted markings on the substrate to indicate block locations. Fasteners need to be installed within 1" of this marked area. On steel decks be sure to fasten into the top flute.
- See pages 12 and 13 of the Cool-Vent Installation Guide for Cool-Vent orientation in regards to steel deck flute direction.

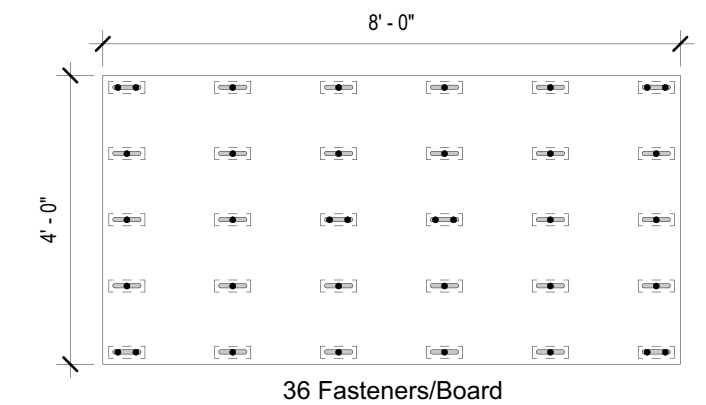
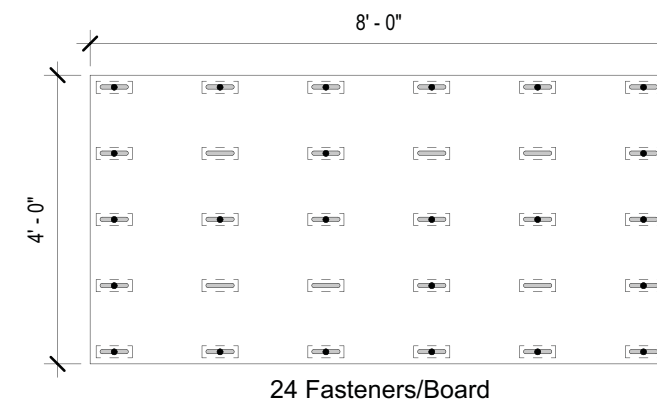
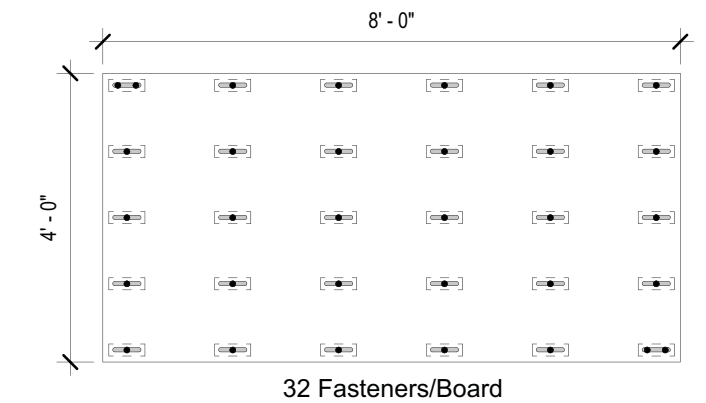
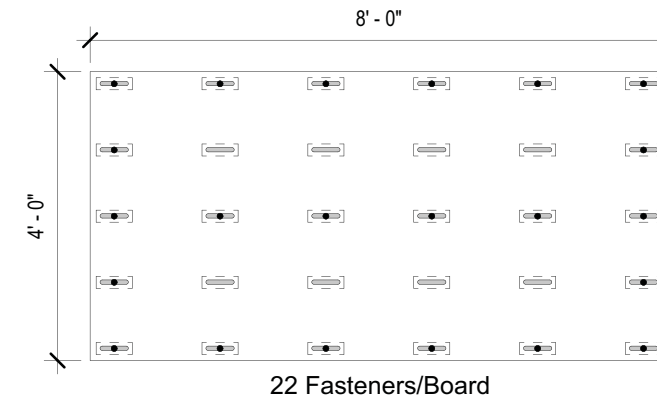
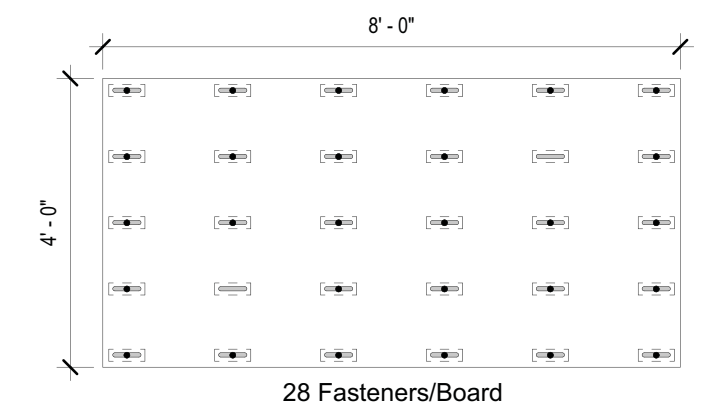
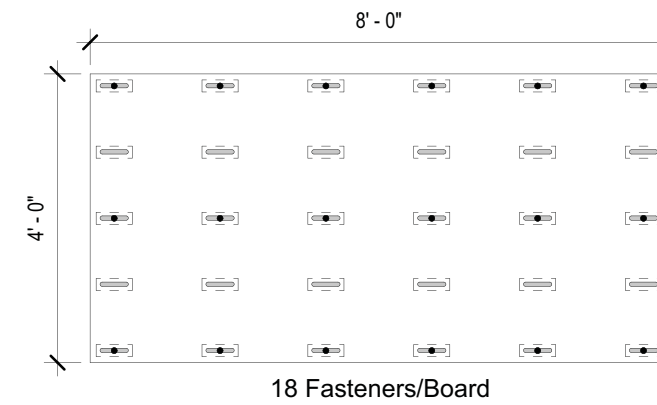

COOL-VENT

Wood, Steel, or Structural Concrete Roof Decks

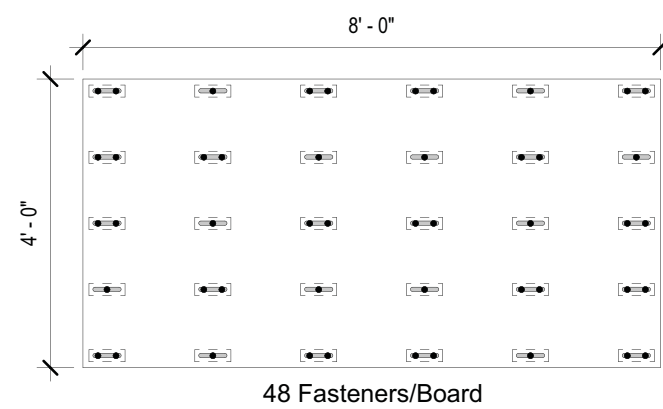
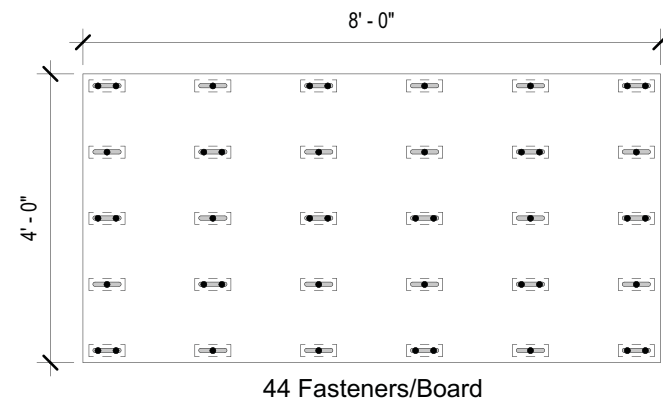
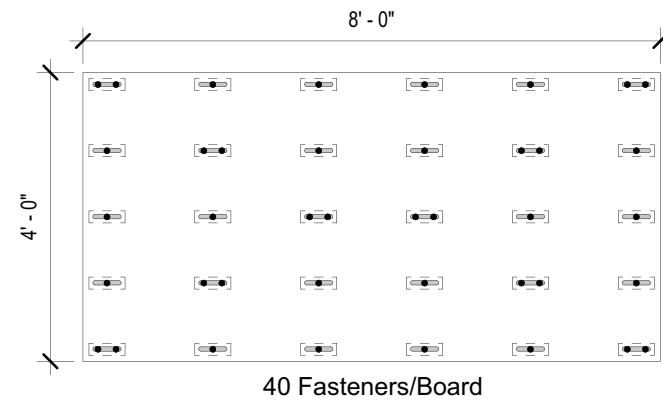

EAVE DETAIL FOR STEEL DECK (TYP)

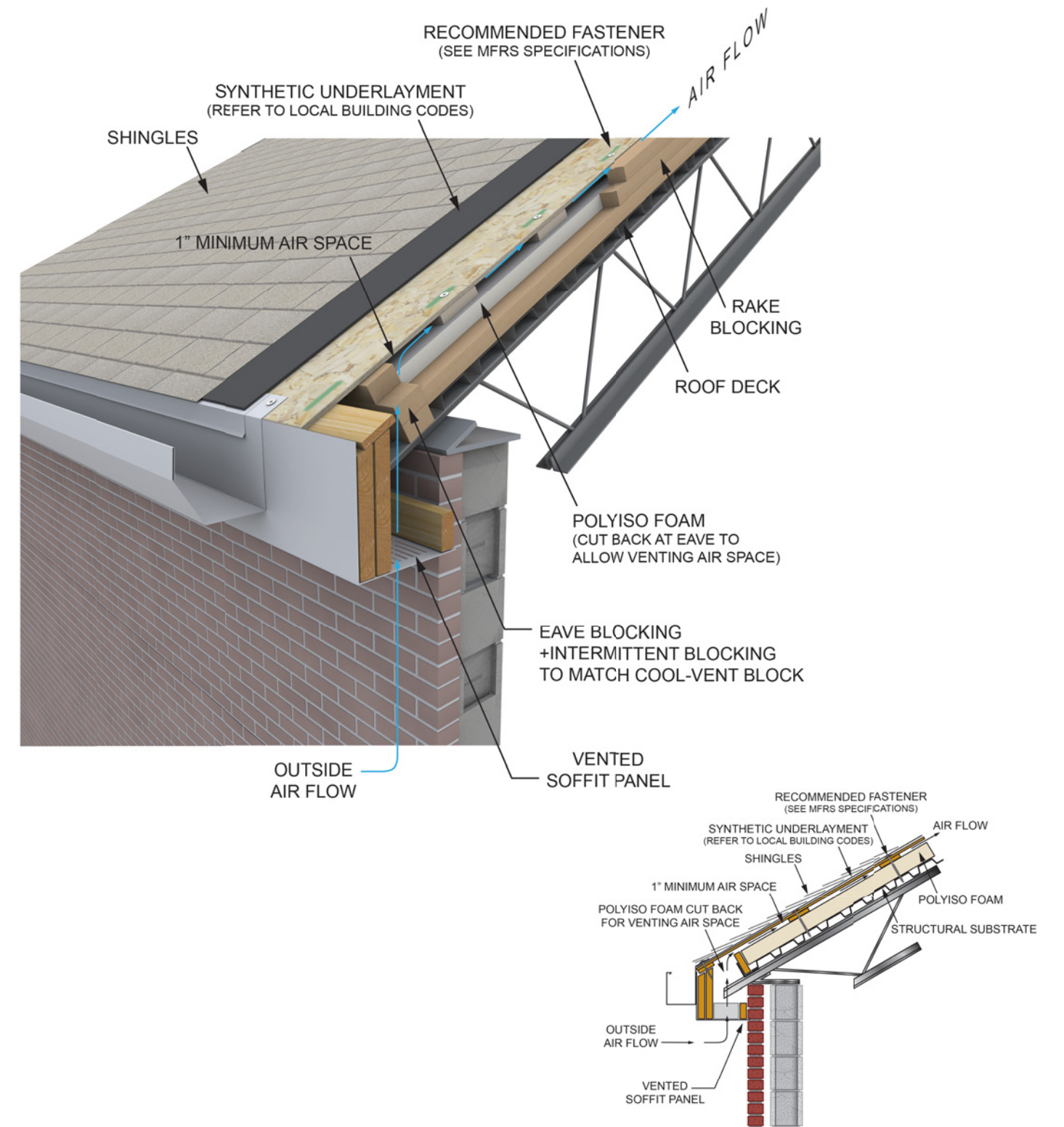

RIDGE DETAIL FOR STEEL DECK (TYP)

NOTES

- It is important that foam butts tightly at top of ridge. Wood substrate should then be cut back to accommodate airflow and ridge cap/vent that is being installed.

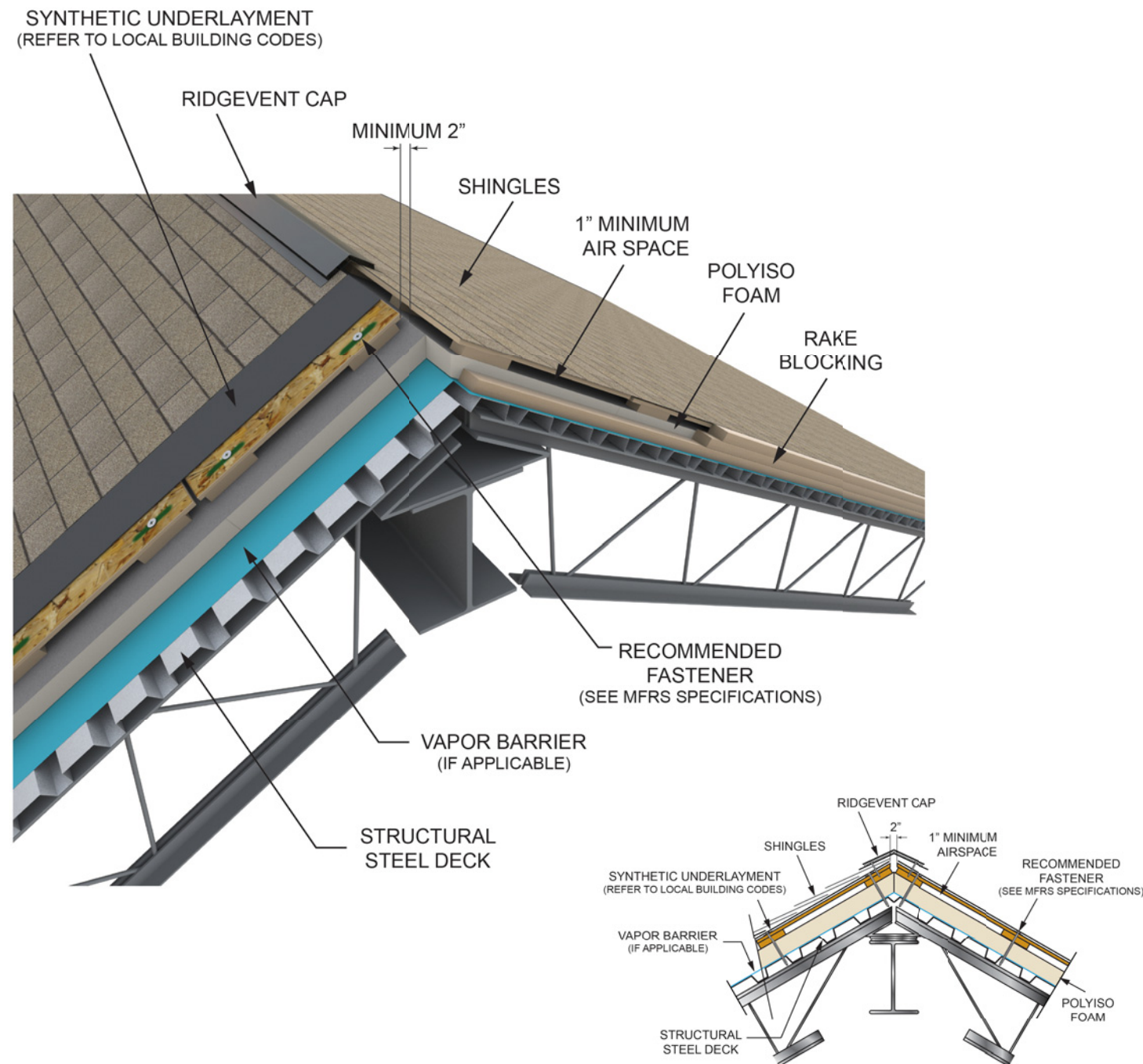

WOOD DECKS

Fastener Information - SIP WD

The Hunter Panels SIP WD Fastener is intended to mechanically attach Cool-Vent and H-Shield NB to wood substrates. The Hunter Panels SIP WD Fastener has the following features:

- FM approved—plates not required
- Pull-out values for plywood
- Star/spider head eliminates need for washer and offers dramatically increased pull-out value
- Multiple bits included in each pail
- 100% American made
- Fast, one-step installation
- No pre-drilling

Test Description	Typical Value
Pull-through (lbs)	630
Pull-out (lbs):	
1/2" plywood	442
5/8" plywood	459
3/4" plywood	710
Douglas Fir (1" pen.)	768

Fasteners should never be struck with a hammer during installation.

PHYSICAL DATA CHART

Head Diameter	.625"
Thread Diameter	.240", .255"
Shank Diameter	.190"
Fastener Length	3.5", 4", 4.5", 5", 5.5", 6", 6.5", 7", 7.5", 8", 9", 10", 11", 12", 13", 14"

- Fastener thread shall extend a minimum of 3/4" beyond the underside of OSB/plywood decks.
- Fastener thread shall penetrate a minimum of 1" into plank/T&G decks.
- Values are per FM 4470.

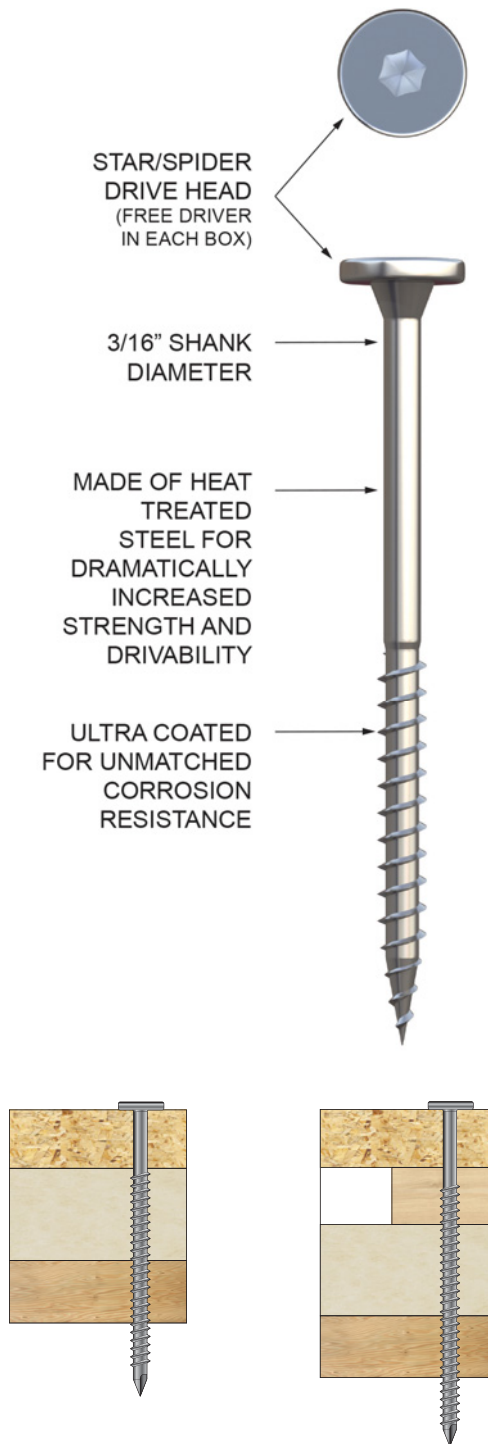

STEEL DECKS

Fastener Information - SIP SD

The Hunter Panels SIP SD Fastener is intended to mechanically attach Cool-Vent and H-Shield NB to 18 – 22 gauge corrugated steel decking and structural concrete. The Hunter Panels SIP SD Fastener has the following features:

- FM approved—plates not required
- Pull-out values for steel
- Star/spider head eliminates need for washer and offers dramatically increased pull-out value
- Multiple bits included in each pail
- 100% American made
- Fast, one-step installation
- No pre-drilling when used on a steel deck

Test Description	Typical Value
Pull-through (lbs)	630
Pull-out (lbs):	
22 gauge metal	510
18 gauge metal	920

Fasteners should never be struck with a hammer during installation.

PHYSICAL DATA CHART

Head Diameter	.625"
Thread Diameter	.240", .255"
Shank Diameter	.190"
Fastener Length	3.5", 4", 4.5", 5", 5.5", 6", 6.5", 7", 7.5", 8", 9", 10", 11", 12", 13"

- Fastener thread shall extend $\frac{3}{4}$ " beyond underside of steel decks.
- For installation into structural concrete, predrill with $\frac{3}{16}$ " masonry bit. Install using a maximum 2,500 rpm screw gun.
- Values are per FM 4470

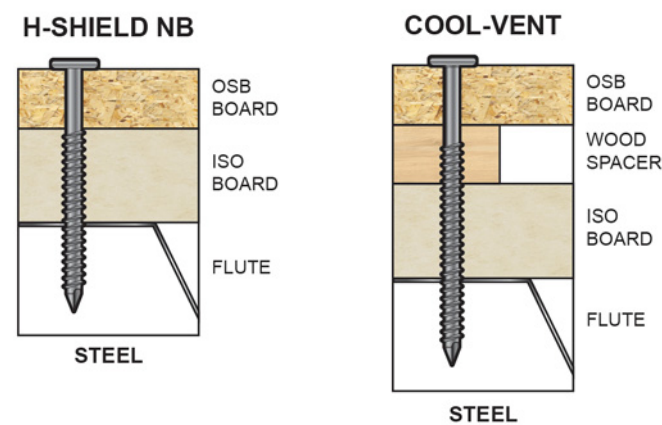
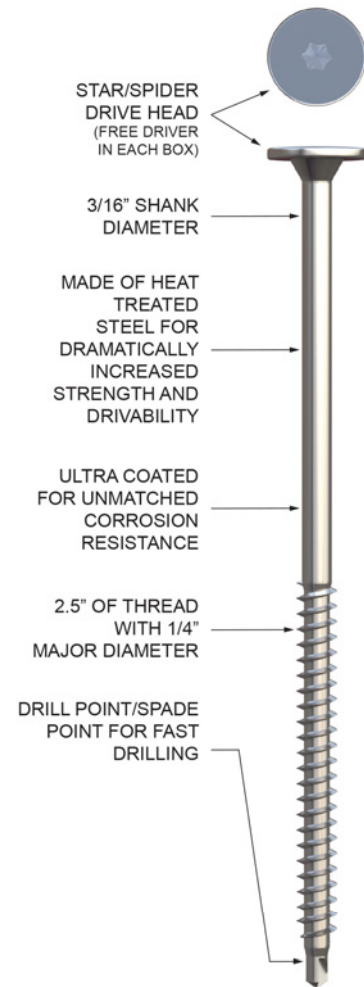

HIP AND VALLEY DETAIL

NOTES

- Some additional spacer blocks may be needed for this valley detail.
- Please save all unused blocks for further use. Additional blocks are available upon request.

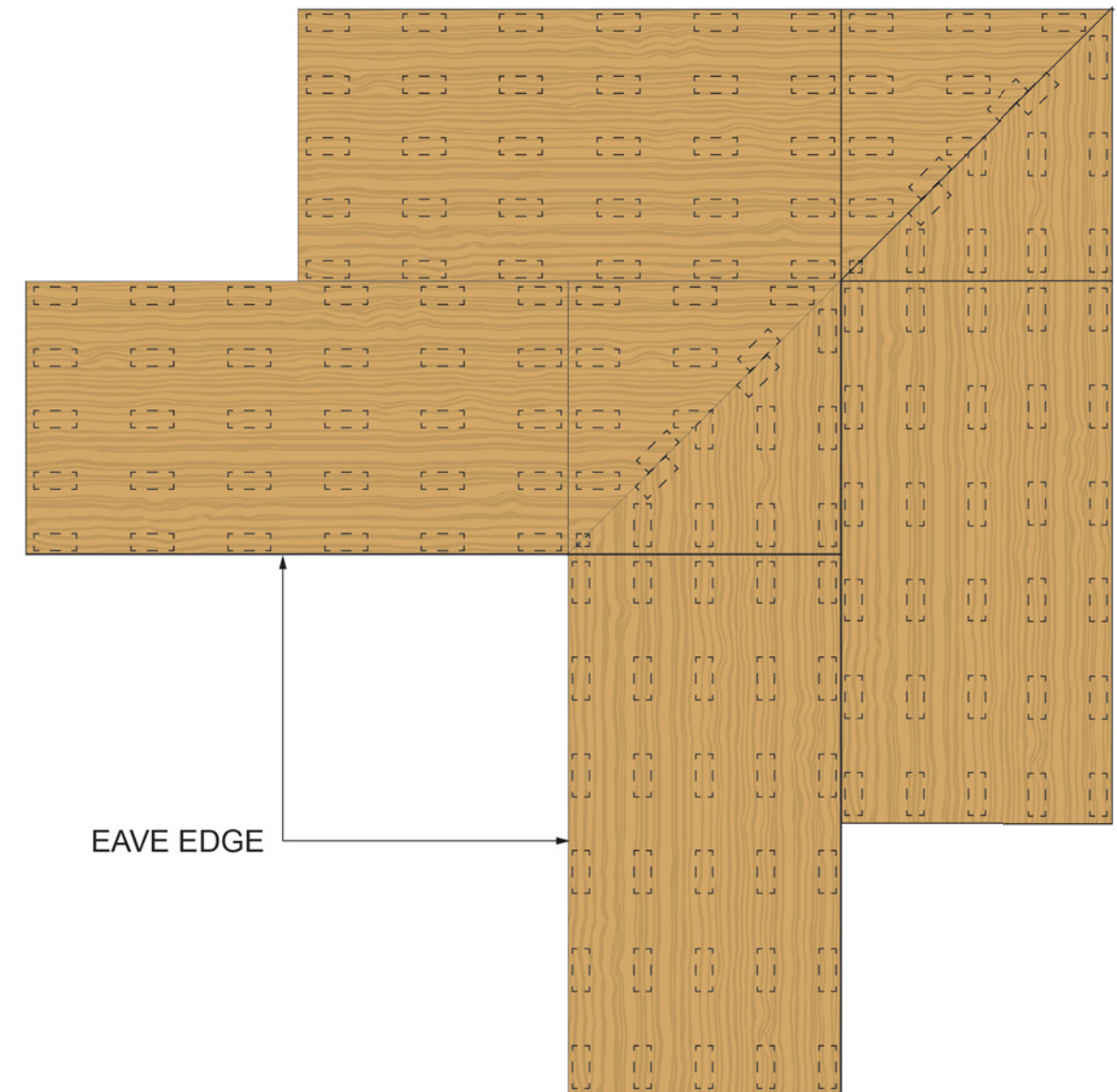

MITERED CORNER DETAIL

HIP AND VALLEY CUTTING

NOTES

- Cool-Vent has been designed to provide two pieces when cut in half.
- For valleys and hips cut a piece of Cool-Vent in half, snap a chalk line from SE corner to NW corner and cut end to end.
- In Diagram #3, you may need to add additional blocks for support along diagonal edges. Do not discard any blocks as they may be used for this detail. Additional blocks are available upon request.

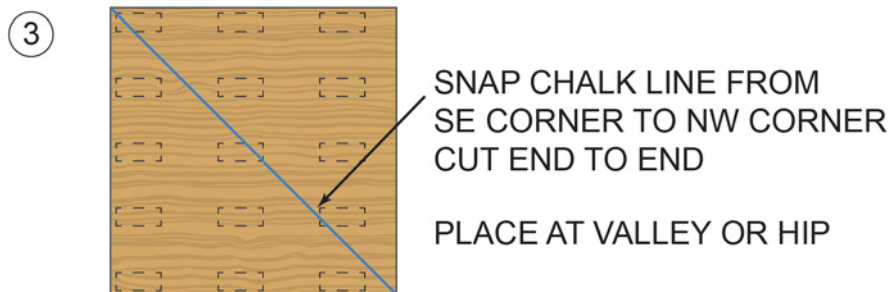
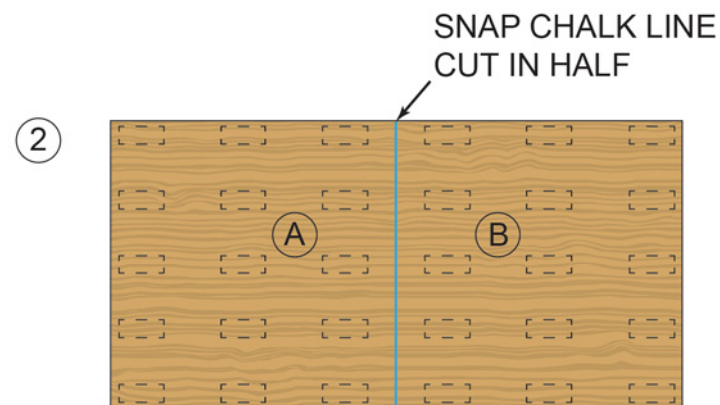
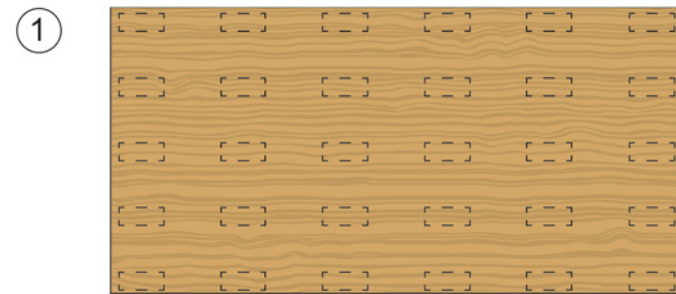

HEAVY DUTY STEEL DECKS

Fastener Information - SIP HD

Hunter Panels SIP HD Fastener is intended to mechanically attach Cool-Vent or Hunter NB to 16 gauge or greater corrugated steel decking. Hunter Panels SIP HD Fastener has the following features:

- FM approved—plates not required
- Pull-out values for steel
- Star/spider head eliminates need for washer and offers dramatically increased pull-out value
- Multiple bits included in each pail
- 100% American made
- Fast, one-step installation
- SIP HD is for 16 gauge or thicker steel deck
- No pre-drilling

Test Description	Typical Value
Pull-through (lbs)	630
Pull-out (lbs):	
Structural Steel 16 ga	770

Fasteners should never be struck with a hammer during installation.

PHYSICAL DATA CHART

Head Diameter	.625"
Thread Diameter	3.875", .212"
Shank Diameter	.212", .190"
Fastener Length	4.5", 6.0", 8.0"

- Fastener thread shall extend $\frac{3}{4}$ " beyond the underside of steel decks.
- Values are per FM 4470.

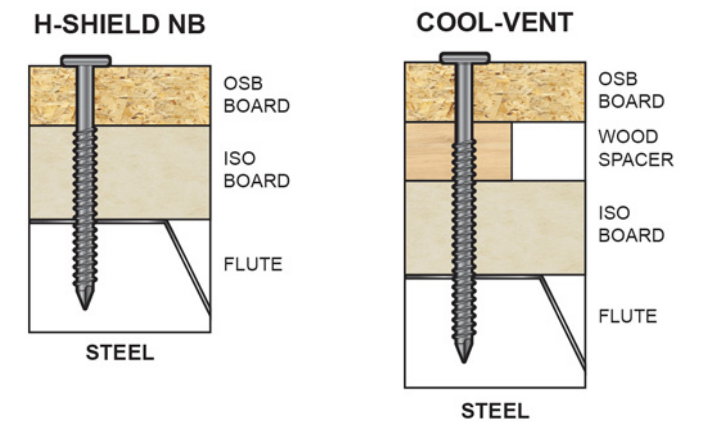
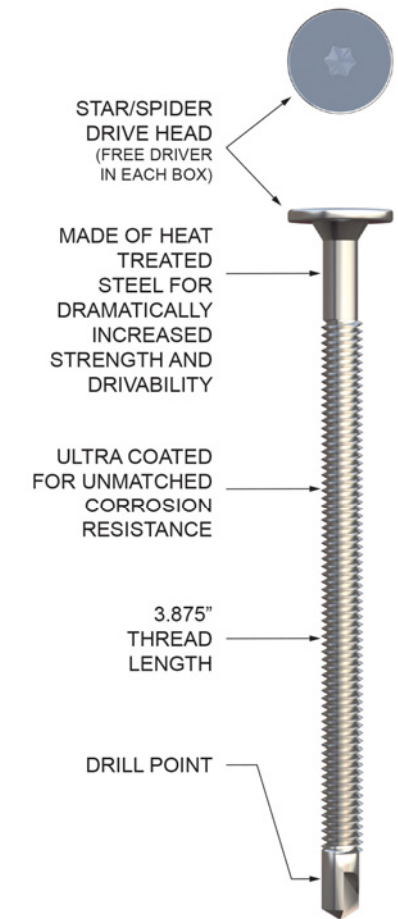

HORIZONTAL STEEL DECK

NOTES

- Run 8' side of Cool-Vent perpendicular to the direction of the flutes of steel decking.

RECOMMENDED INSTALLATION OF COOL-VENT STEEL DECK RUNNING HORIZONTALLY

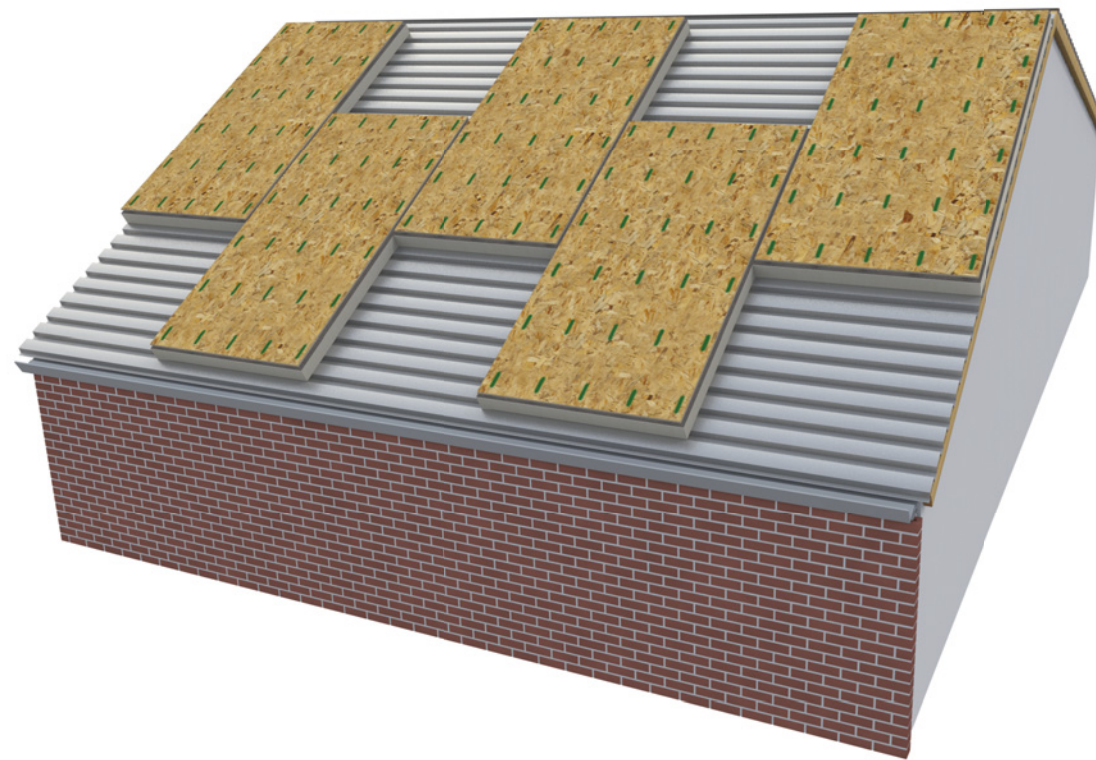

EAVE AND RAKE DETAIL

NOTES

Vapor Retarder

- Perm rating should be .5 or less as determined by ASTM E-96. The need for and location of a vapor retarder system varies depending on the location, climate conditions and the intended use of the structure beneath it. **Consult a licensed architect or engineer for recommendations regarding this important design consideration.**

Eave Edge

- Pressure treated blocking equal to the foam thickness of Cool-Vent shall be installed along the eave edge. Cool-Vent foam should then be trimmed back to equal eave blocking and then spacers and substrate to be placed on top of eave blocking and secured to allow air flow at eave.
- Do not discard wood spacers from Cool-Vent when applying along the eave, as they can be used at another juncture in the installation.

Rake Edge

- Pressure treated nailer(s) equal to the Cool-Vent overall thickness, shall be installed along the rake to protect exposed edge of insulation. Ice and watershed or approved shingle felt should then be applied to furthest edge of rake blocking and secured per manufacturers specifications.
- Do not discard wood spacers from Cool-Vent when applying along the rake.

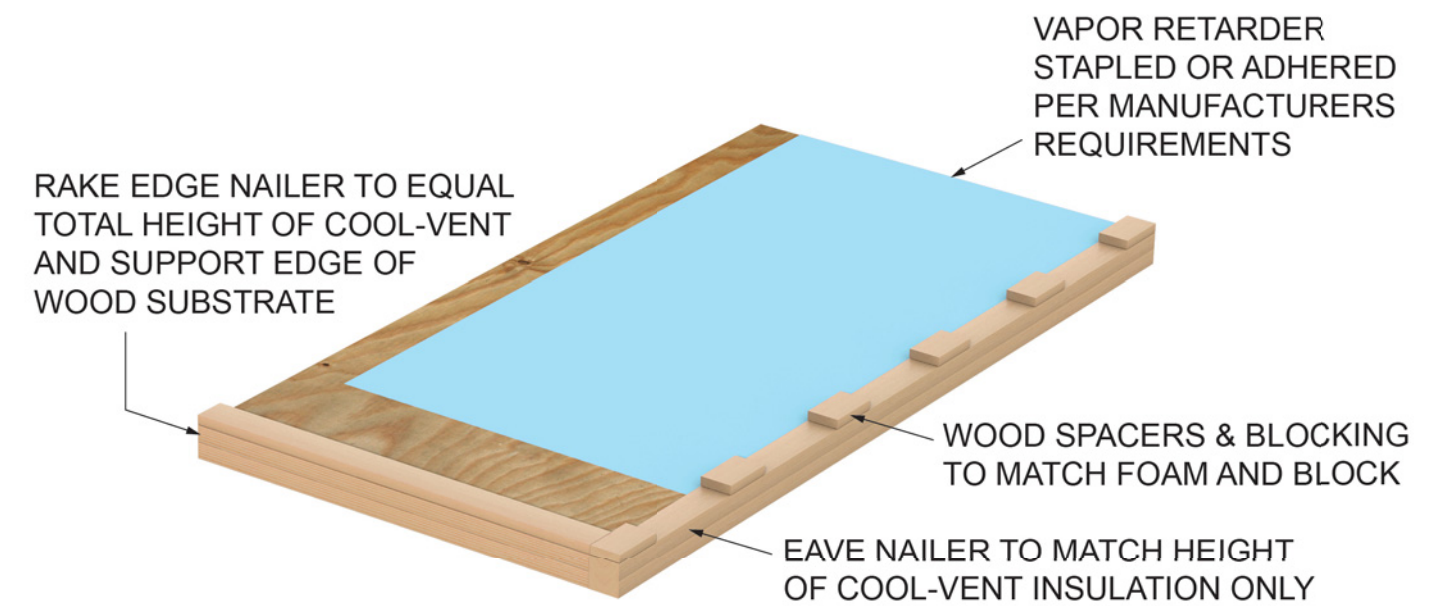

GETTING STARTED

NOTES

- Stagger rows by following Cool-Vent layout above. Cool-Vent can be cut 48" o.c. to provide two equal halves, no waste then occurred. (DO NOT DISCARD UNUSED BLOCKS.)

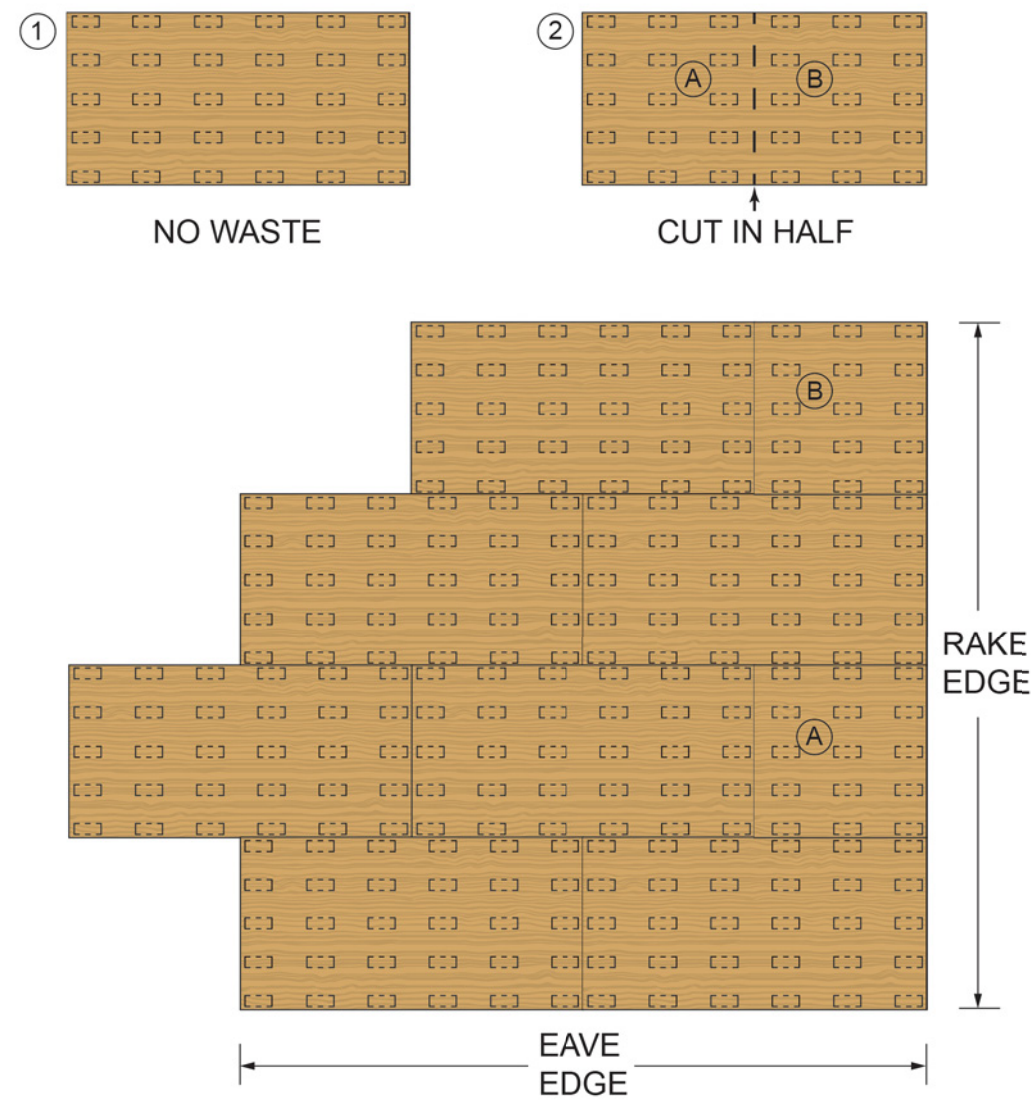

VERTICAL STEEL DECK

NOTES

- Run 8' side of Cool-Vent perpendicular to the direction of the flutes of steel decking.

RECOMMENDED INSTALLATION OF COOL-VENT STEEL DECK RUNNING VERTICALLY

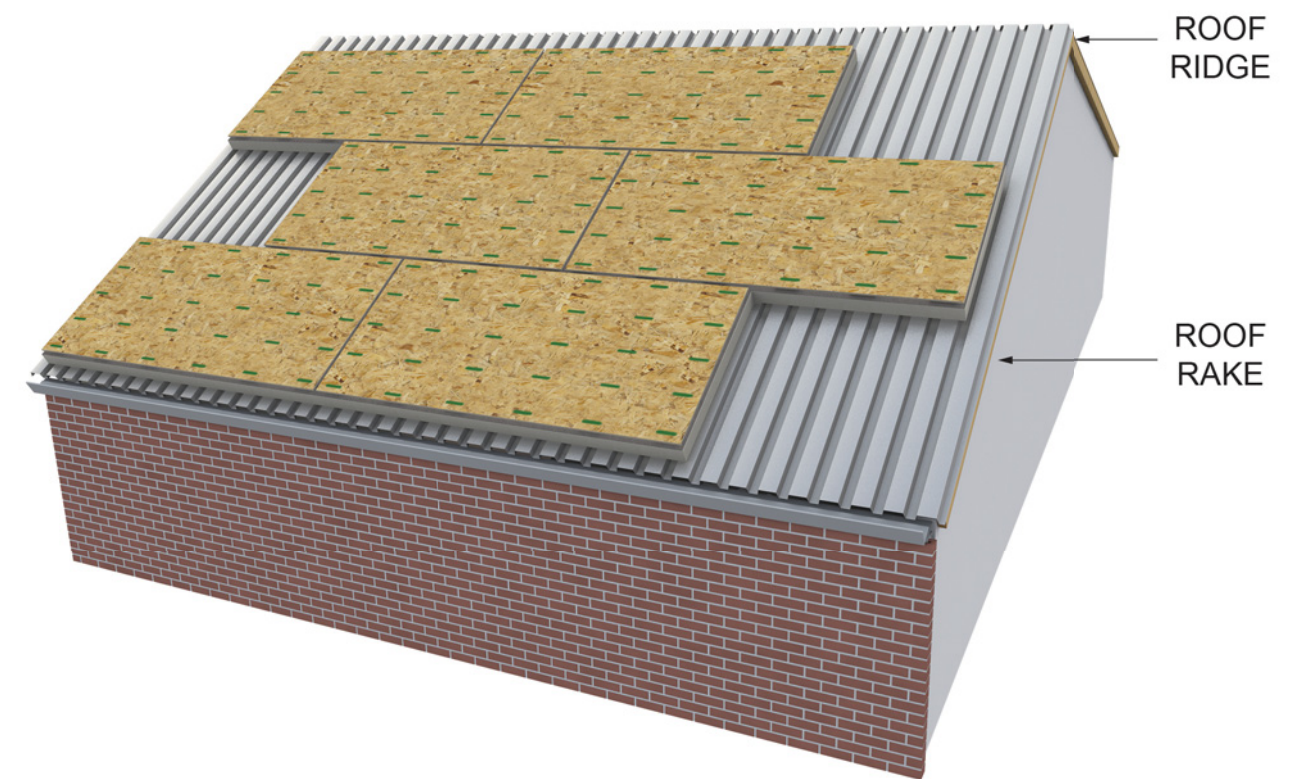

SUGGESTED LAYOUT FOR TWO-LAYER SYSTEM

Cool-Vent over flat polyiso

NOTES

- Recommend a minimum of 6" stagger on all sides of the base layer and subsequent layers of polyiso being installed in a multi-layer system.

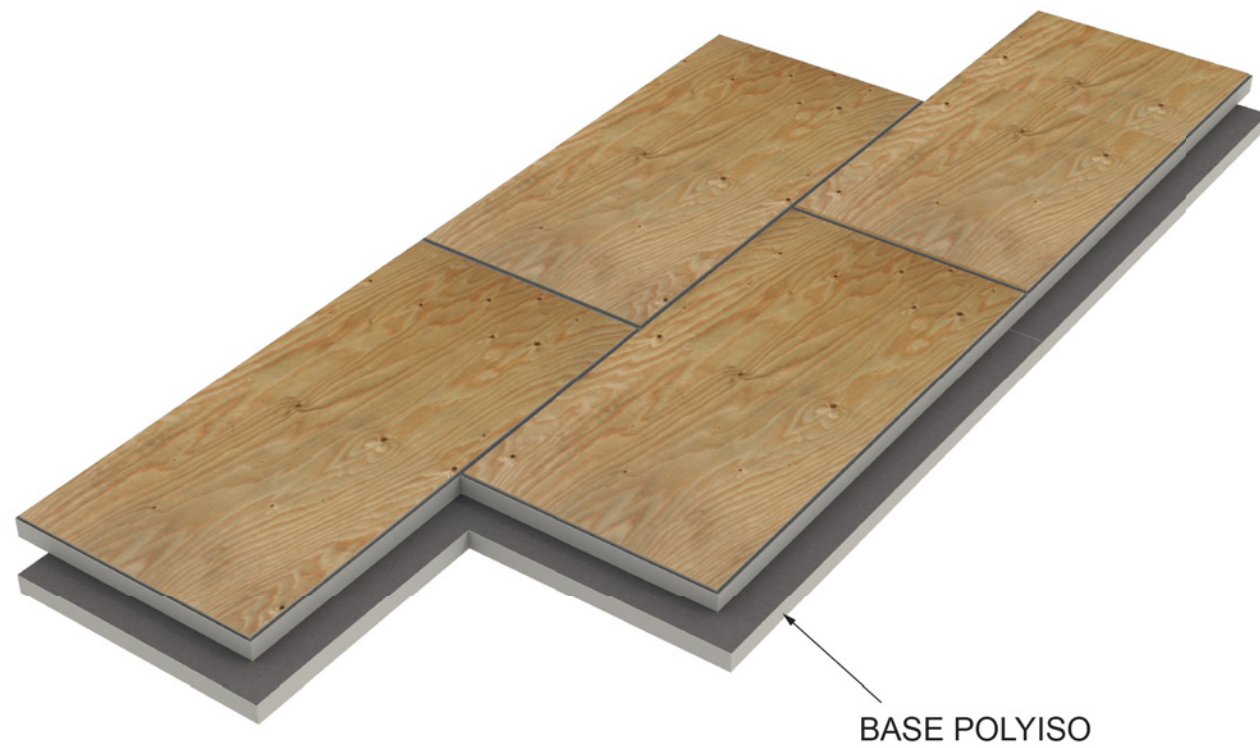

RABBETED EDGE DETAIL

NOTES

Rabbeted Edge Definition

- The wood substrate on Cool-Vent is rabbeted (routed) back on all four wood sides to allow for expansion of the wood substrate.

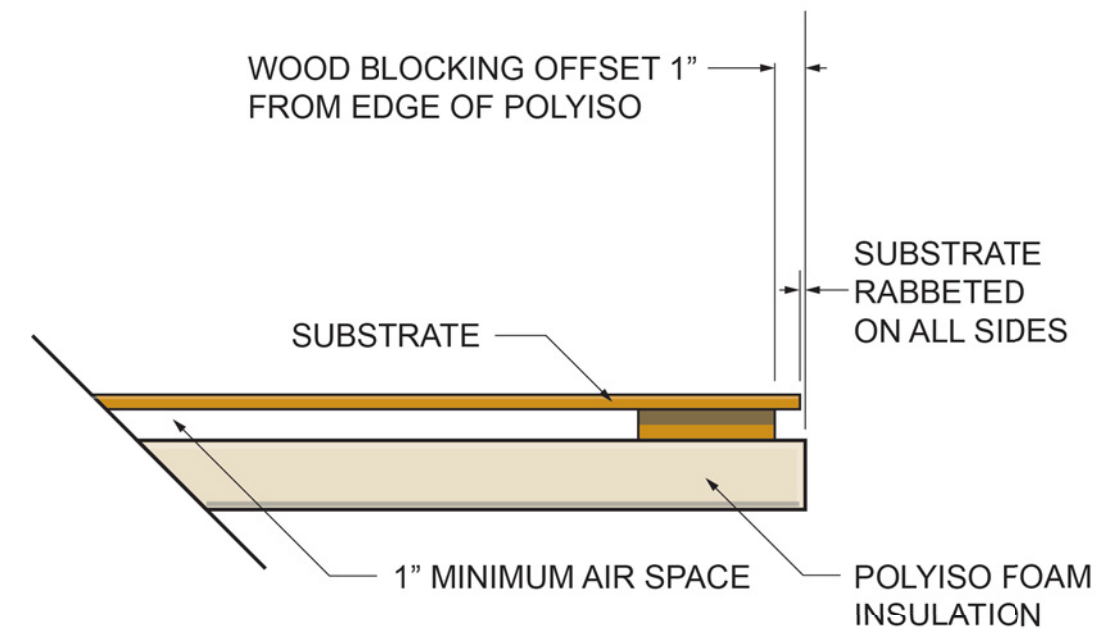

INSULATION EDGE DETAIL